

## E4 Touch Panel (RGBW)



E4

Manual  
www.ltech-led.com

### LT-BUS®

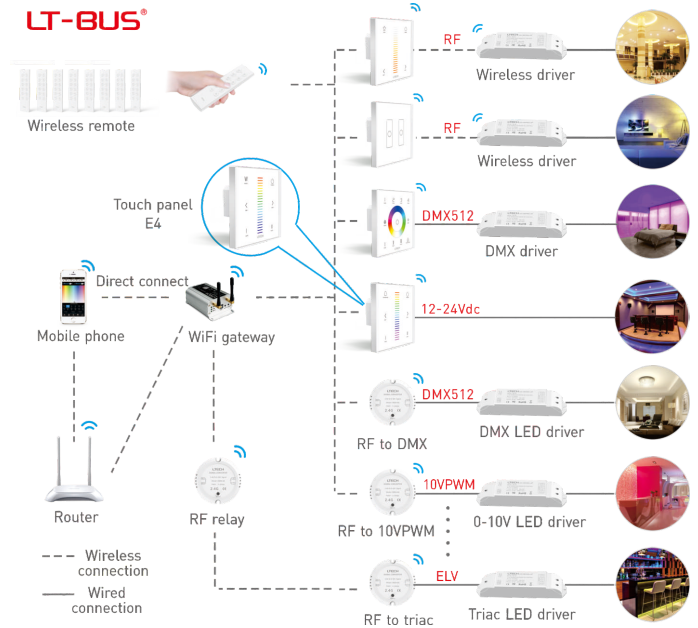

## Product Features

- 2 in 1 function: RF wireless control and PWM power output.
- Power output, lamps can be connected directly, easy and convenient.
- Touch keys with chord and LED indicator.
- Save any scene you like, touch 1 key to recall scene, easy and convenient.
- Adopts capacitive touch control technology on the full color slider, makes LED color selection more user-friendly.
- Touch panel can be controlled by remote directly or smart phone if add a gateway.

## Technical Specs

### E4 RGBW Touch Panel





Input Voltage:	12-24Vdc
Current Load:	3A×4CH Max. 12A
Output Power:	[0~36W...72W]×4CH Max. 288W
Wireless Frequency:	RF 2.4GHz
Working Temp.:	-20°C~55°C
Dimensions:	L86×W86×H36(mm)
Package Size:	L113×W112×H50(mm)
Weight(G.W.):	225g

LTECH

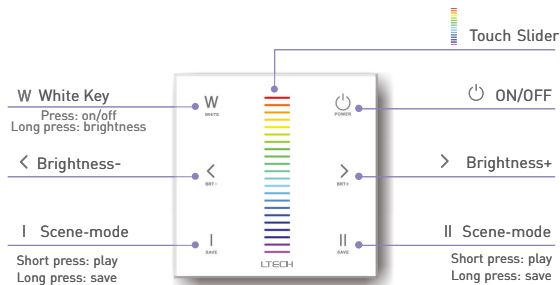
## Key Functions:

LTECH



- \* When blue status light of  key is on, long press  to turn on/off buzzer.
- When white status light of  key is on, long press  to match code.
- Panel's 2 scene-mode keys are corresponding with WiFi-106 gateway APP's 1 & 2 scene-mode key, the scenes can be changed by APP or panel.

## Terminals:

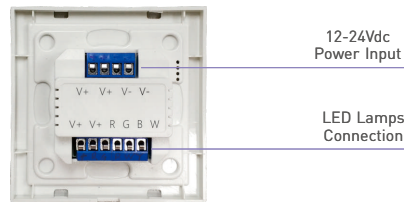

## Installation Instruction

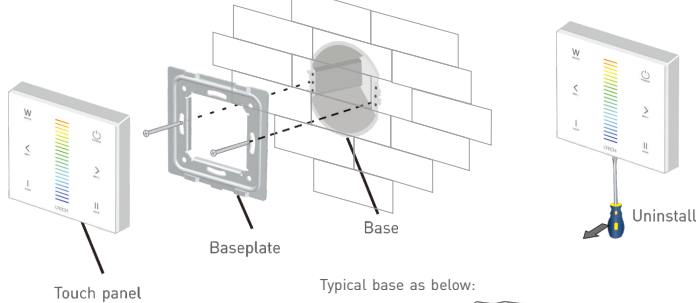

LTECH

## Product Size

Unit: mm

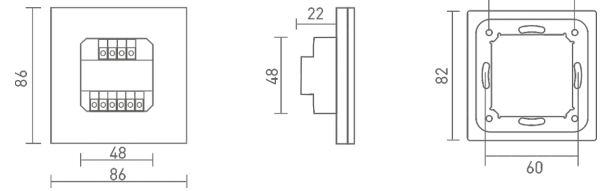

Typical base as below:

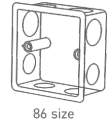

## Wiring Diagram

LTECH



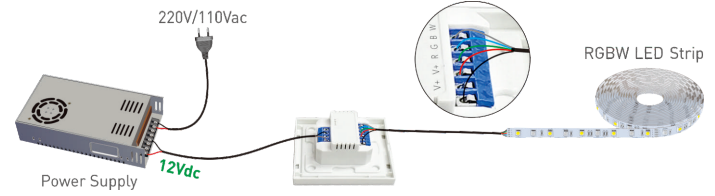



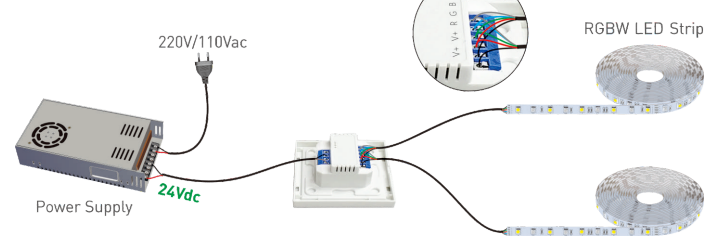





E.g 1: Connect with 12V strip, Max. 144W.



E.g 2: Connect with 24V strip, Max. 288W.



## Application Composition

1.  +   
Touch panel + Lamps
2.  +  +   
Touch panel + Remote + Lamps
3.  +  +   
Touch panel + WiFi master controller + Lamps
4.  +  +  +   
Touch panel + WiFi master controller + Remote + Lamps

LTECH

## Match Code Sequence

LTECH

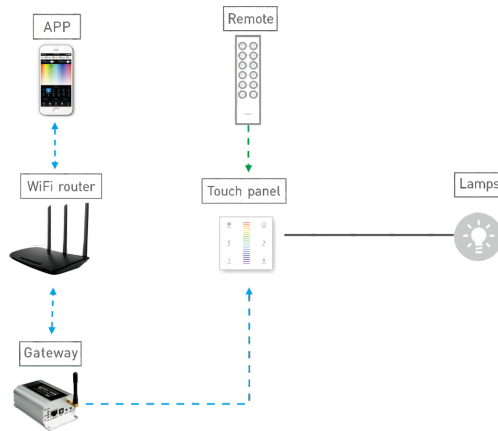

\* PS: No WiFi router needed when gateway work with phones directly.

### Match Code Sequence

1. Configure gateway with touch panel, which enables the smart phone to control lamps via gateway.
2. Configure remote with touch panel, which enables remote to control lamps.

# RF Wireless Wiring



## Single Zone Control

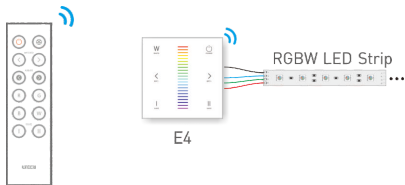

Single Zone Remote F4

## Multiple Zones Control

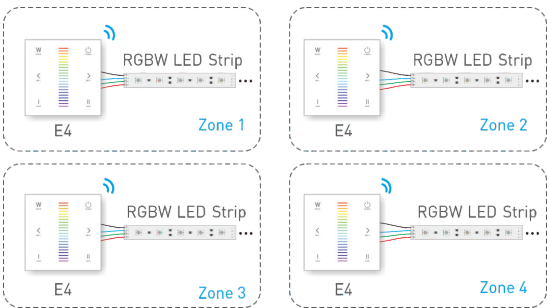
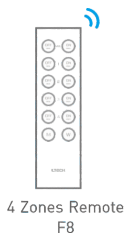

\* Touch panels can be sync controlled by multi remotes, Please refer to the manual of remote's usage.

# Match Code between Touch Panel & Remote



1.

Long press on touch panel until all status lights flicker.

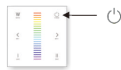

2.

Press any key on F4 remote (or the matching zone key on F8), the status light stop flickering, match successfully.



# Match code between touch panel & gateway

1.

Long press on touch panel until all status lights flicker.

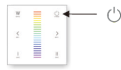

2.

Click the corresponding RGBW zone on mobile phone, then touch the color screen, match successfully.



## Clear code:



Press I II on touch panel simultaneously for 5 seconds, the status light flicker several times, clear code successfully.

\* Please match/clear code when panel is on (white status light of key is on).